

# Performance curves:

## UTS 125-80-250



### Impeller

Type: <b>Closed</b>	Max. Ø: <b>259 [mm]</b>	Min. Ø: <b>200 [mm]</b>	Sel. Ø:	Outlet width: <b>0 [mm]</b>	Bearing bracket:
------------------------	----------------------------	----------------------------	---------	--------------------------------	------------------

### Operating data

Speed: <b>2950 [rpm]</b>	Frequency:	Duty point: Q=	H=	Suction port: <b>125 [mm]</b>	Discharge port: <b>80 [mm]</b>
-----------------------------	------------	-------------------	----	----------------------------------	-----------------------------------

Power data referred to: Water; 1.000 [kg/dm³]; 20.0 [yC]

Curve number: UTS125-80-25029

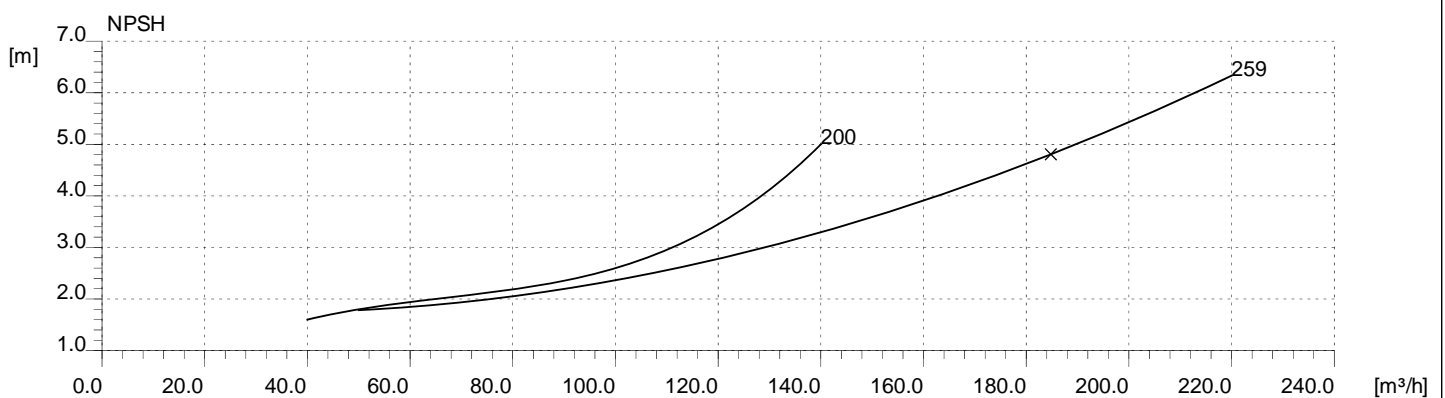
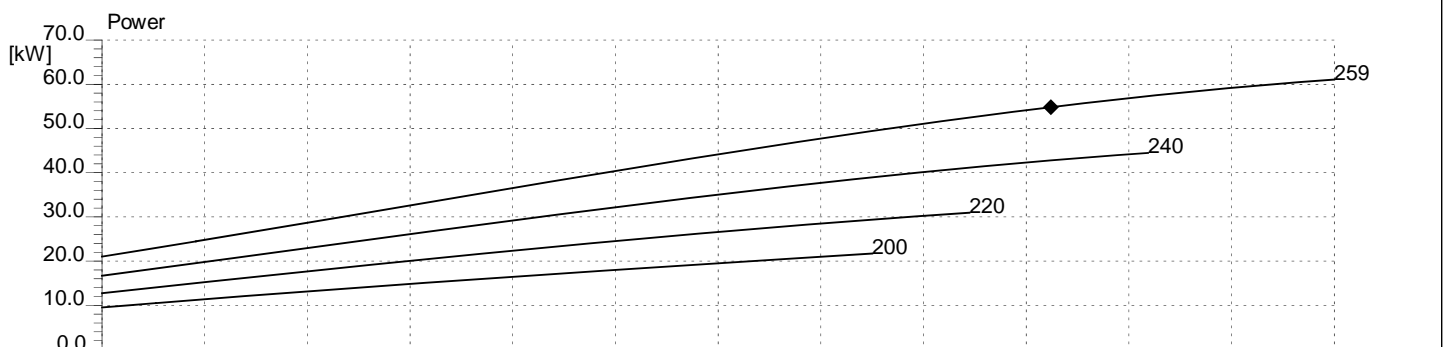
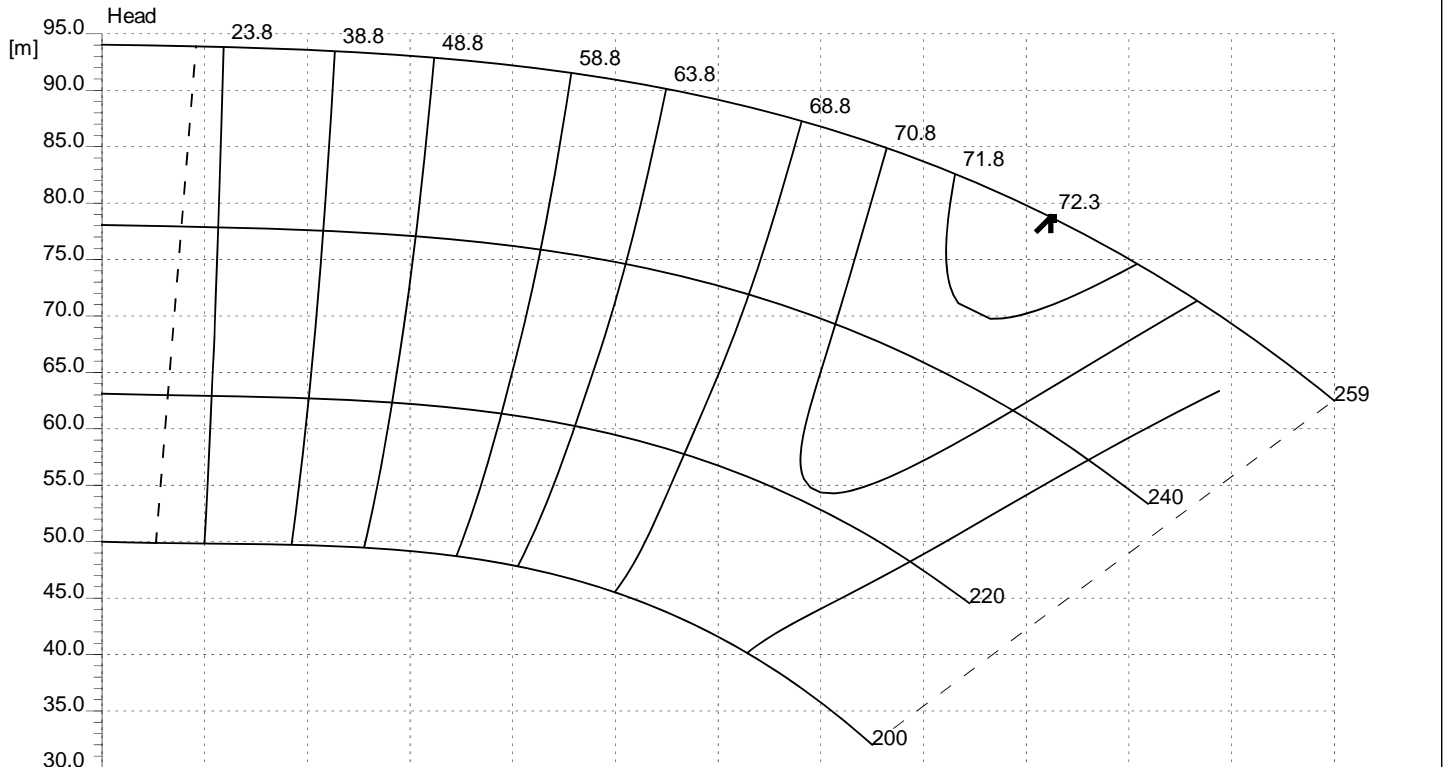

Project:	Project no.:	Created by:	Date: <b>2007-01-26</b>
----------	--------------	-------------	----------------------------